

Nos. 205 and 205-P (Plastic)

Capacity: 1/4" through 2 3/8"

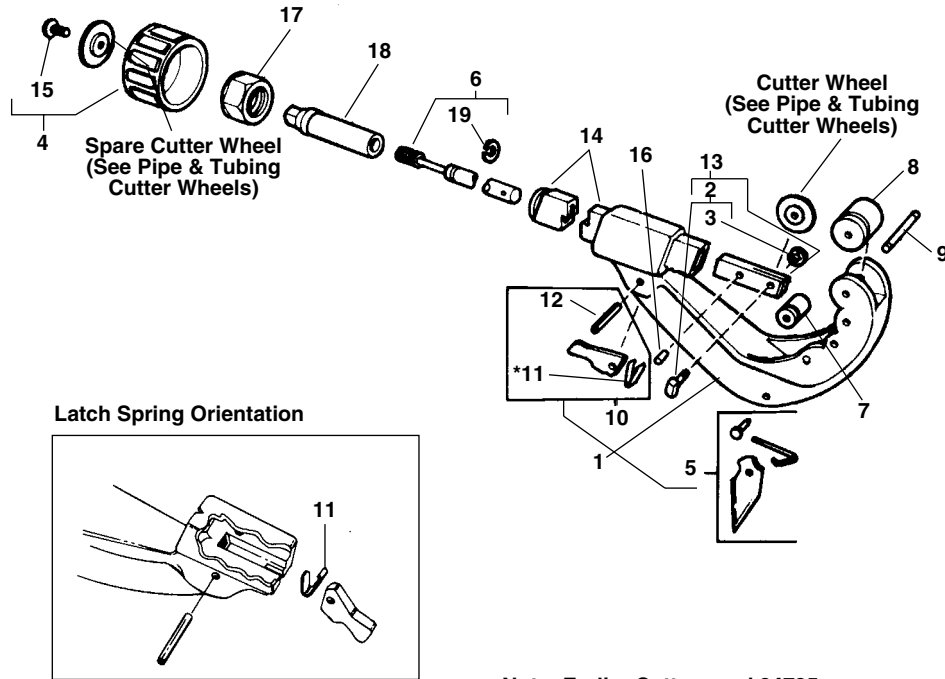

Note: Earlier Cutter used 34735 Wheel Screw and 45175 Washer. Update by using 34700

NOTE: Order parts by Catalog Number only. DO NOT order by Reference Number.

Ref. No.	Catalog No.	Description
1	33395	Frame Assembly
2	33805	Pin and Clip
3	74740	Clip
4	34625	Knob Assembly
5	34650	Reamer Blade Assembly
6	34660	Feed Screw Assembly
7	34665	Small Roll (2)
8	34670	Large Roll (2)
9	32112	Roll Pin (4)
10	34680	Latch Assembly
11	34685	Latch Spring
12	34690	Latch Pin
13	34700	Slide Bar Assembly
14	34705	Ratchet Shaft
15	34750	Screw with Washer
16	34720	Pin
17	34725	Bearing Cap
18	34730	Feed Screw Nut
19	34745	Snap Ring